

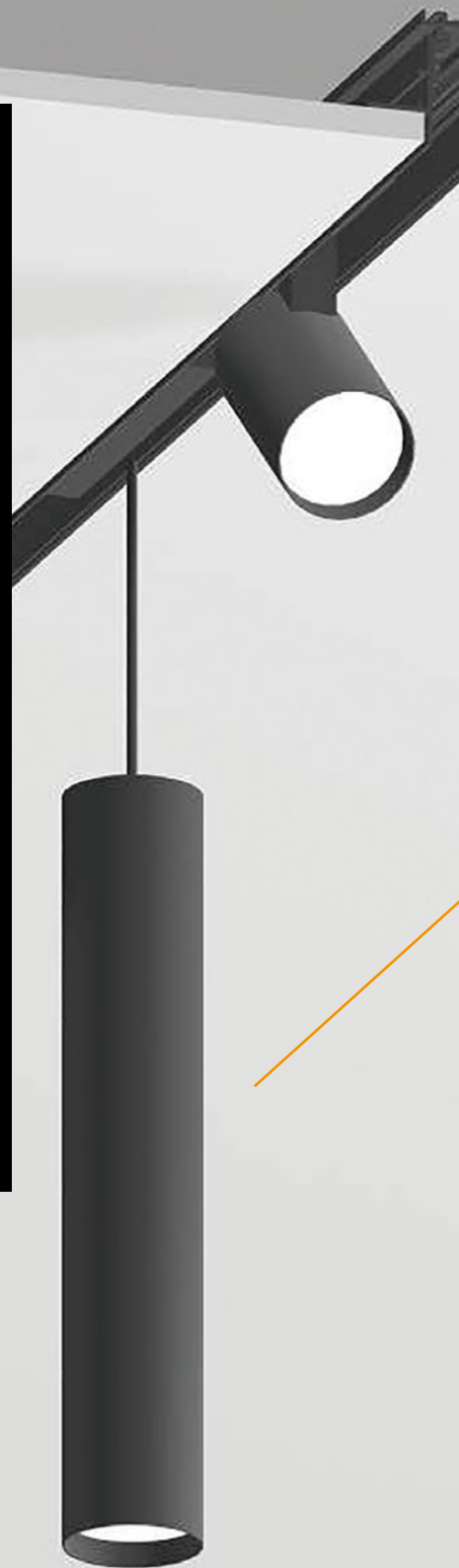

LOW VOLTAGE SYSTEMS

Modular low voltage profile light system with 26,2mm width. Various aluminium profiles and light inserts give possibility creating countless combinations. Surface mounted, suspended or recessed versions. Light inserts can be installed and moved without tools.





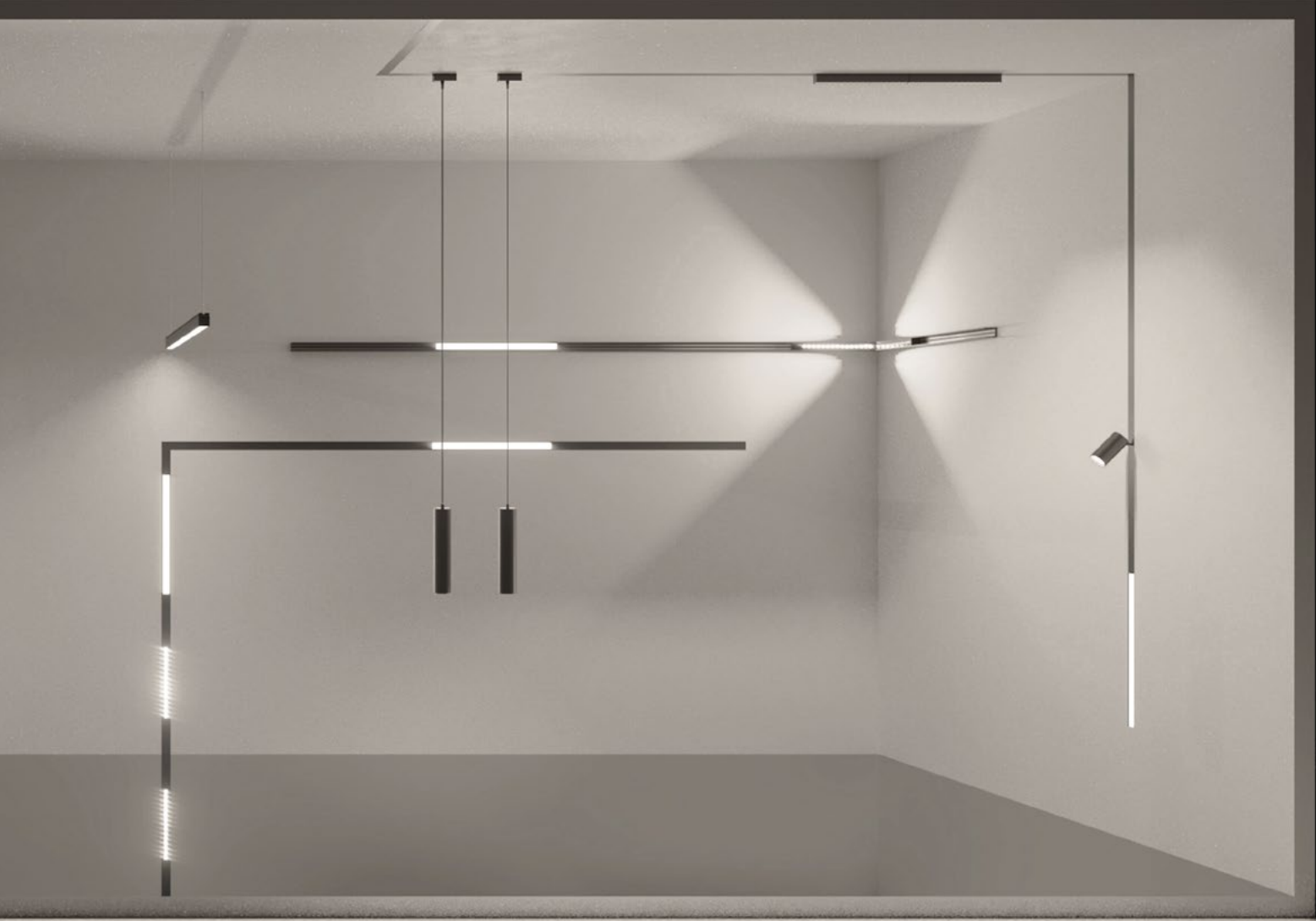





Aluminium profiles

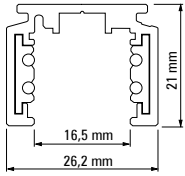

LTS 509
Low aluminum profile for surface and ceiling / suspension mounting

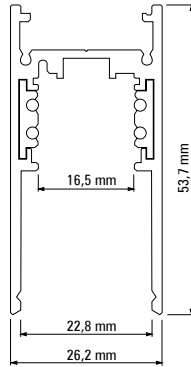

LTS 510
High aluminum profile for surface and ceiling / suspension mounting

Light inserts

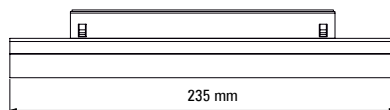
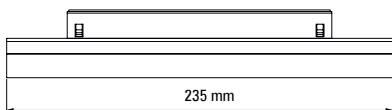

LTS 531

LTS 532

LTS 537

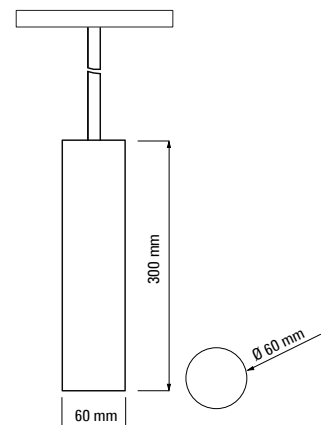

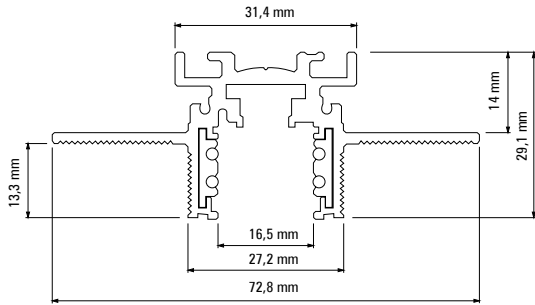



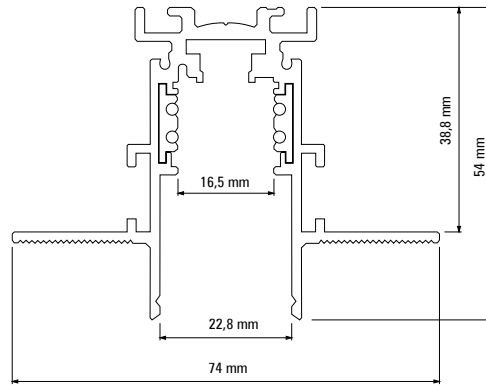



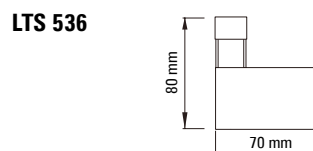
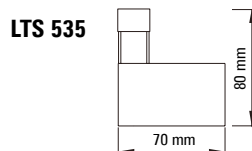
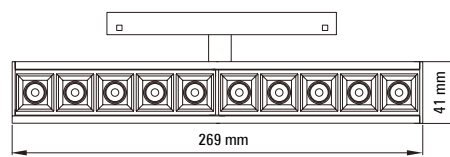
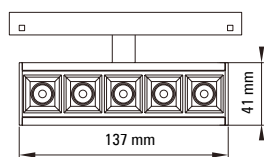
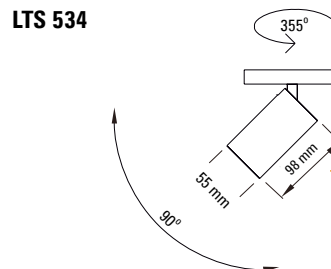
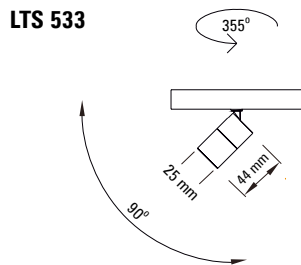



















LTS 511
Low aluminum profile for recessed mounting





LTS 512
High aluminum profile for recessed mounting

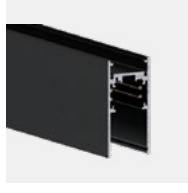
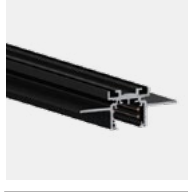

Type		Power [W]	Lenght [mm]	CRI+CCT	Reflector [DEG]	Lumen output [lm]	Dimming	Colour
Light inserts								
	LTS 531 8/1 930 24DEG PM 	8	235	930	24	500	 ON/OFF DALI CASAMBI	 BL (BLACK)
	LTS 532 8/1 930 120DEG PM 	8	235	930	120	500	 ON/OFF DALI CASAMBI	 BL (BLACK)
	LTS 533 1/3 20EG 930 	3	44	930	24	220	 ON/OFF DALI CASAMBI	 BL (BLACK)
	LTS 534 1/10 24DEG 930 	10	110	930	24	800	 ON/OFF DALI CASAMBI	 BL (BLACK)
	LTS 535 5/2 30DEG 930 	10	245	930	24	700	 ON/OFF DALI CASAMBI	 BL (BLACK)
	LTS 536 10/2 30DEG 930 	20	245	930	24	1400	 ON/OFF DALI CASAMBI	 BL (BLACK)

Type	Power [W]	Lenght [mm]	CRI+CCT	Reflector [DEG]	Lumen output [lm]	Dimming	Colour
Light inserts							
	LTS 537 1/10 24DEG 930 PM	10	300	930	24	700	■ ON/OFF ■ DALI ■ CASAMBI ■ BL (BLACK)

Type	Lenght [mm]	Colour
Aluminium profiles		
	Low aluminum profile for surface and ceiling / suspension mounting	
	LTS 509 EP 1000 [cut to required length]	1000 WH (WHITE)
LTS 509 EP 2000 [cut to required length]	2000 BL (BLACK)	
	High aluminum profile for surface and ceiling / suspension mounting	
	LTS 510 EP 1000 [cut to required length]	1000 WH (WHITE)
LTS 510 EP 2000 [cut to required length]	2000 BL (BLACK)	
	Low aluminum profile for recessed mounting	
	LTS 511 EP 1000 [cut to required length]	1000 WH (WHITE)
LTS 511 EP 2000 [cut to required length]	2000 BL (BLACK)	
	High aluminum profile for recessed mounting	
	LTS 512 EP 1000 [cut to required length]	1000 WH (WHITE)
LTS 512 EP 2000 [cut to required length]	2000 BL (BLACK)	
	Plastic Blind Cover for all types of profiles (option)	
LTS 500 PBC	1000	■ WH (WHITE) ■ BL (BLACK)

Type

Colour

Electrical and mechanical connectors (for all types of profiles)**Electrical short end-feed**

LTS 500 ESF ■

 ■
 WH (WHITE)
 BL (BLACK)
**Electrical straight connector**

LTS 500 ESC ■

 ■
 WH (WHITE)
 BL (BLACK)
**Mechanical straight connector**

LTS 500 MSC ■

 ■
 WH (WHITE)
 BL (BLACK)
**Electrical L connector**

LTS 500 ELC ■

 ■
 WH (WHITE)
 BL (BLACK)
**Electrical flexible connector**

LTS 500 EFC ■

 ■
 WH (WHITE)
 BL (BLACK)
**Mechanical L connector**

LTS 500 MLC ■

End Caps



LTS 509 EC ■

 ■
 WH (WHITE)
 BL (BLACK)

LTS 510 EC ■

 ■
 WH (WHITE)
 BL (BLACK)





Power supply 230V/48W

Type	Colour
 <p>Mounted above the recessed ceiling LTS 500 PS 48VDC 75W LTS 500 PS 48VDC 150W</p>	
 <p>Mounted on ceiling LTS 500 PS 48VDC 100W CM</p>	<p>WH (WHITE) BL (BLACK)</p>
 <p>Mounted on ceiling for hanging systems with 2000mm cable LTS 500 PS 48VDC 100W CSM 2000</p>	<p>WH (WHITE) BL (BLACK)</p>

L Junction 90DEG horizontal for LTS 510

 <p>LTS 510 HLJ</p>	<p>WH (WHITE) BL (BLACK)</p>
--	----------------------------------

Ceiling & suspension brackets

 <p>LTS 509 SSB (only for LTS 509 profile)</p>	<p>WH (WHITE) BL (BLACK)</p>
 <p>LTS 509 SLB (only for LTS 509 profile)</p>	<p>WH (WHITE) BL (BLACK)</p>
 <p>LTS 510 SSB (only for LTS 510 profile)</p>	
 <p>LTS 510 SLB (only for LTS 510 profile)</p>	

Type

Colour

Ceiling & suspension brackets

LTS 511/512 ILC ■

■
WH (WHITE)
BL (BLACK)

LTS 500 CB

**Suspension Wire Kit**

LTS 500 SWK 2000





