

LINEA M [SYSTEM]

Modular LED aluminium profile system

Designed for continuous lighting systems with different shapes and individual luminaires

Low power version: 14W | 1200lm | 1000mm length | luminaire

Medium power version: 27W | 2200lm | 1000mm length | luminaire

Many different junctions and connectors to create any lighting structures

High performance opal diffuser

Surface mounted or suspended

Height-adjustable cord suspension with transparent power supply cable

and ceiling base for suspended version

CCT= 3000K | 3500K | 4000K | other on request

CRI(Ra) > 80 as standard | CRI(Ra)>90 on request

MacAdam 3

5 years guarantee

220-240V 50/60 Hz Power supply

ON/OFF | DALI | CASAMBI | BLL | TUNABLE WHITE



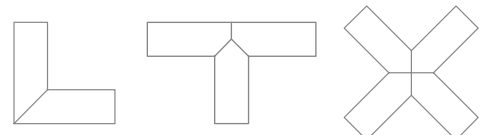

Anodized/White/Black other colours on request

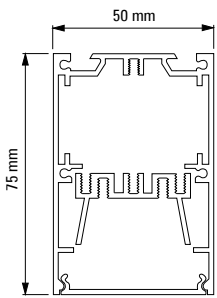
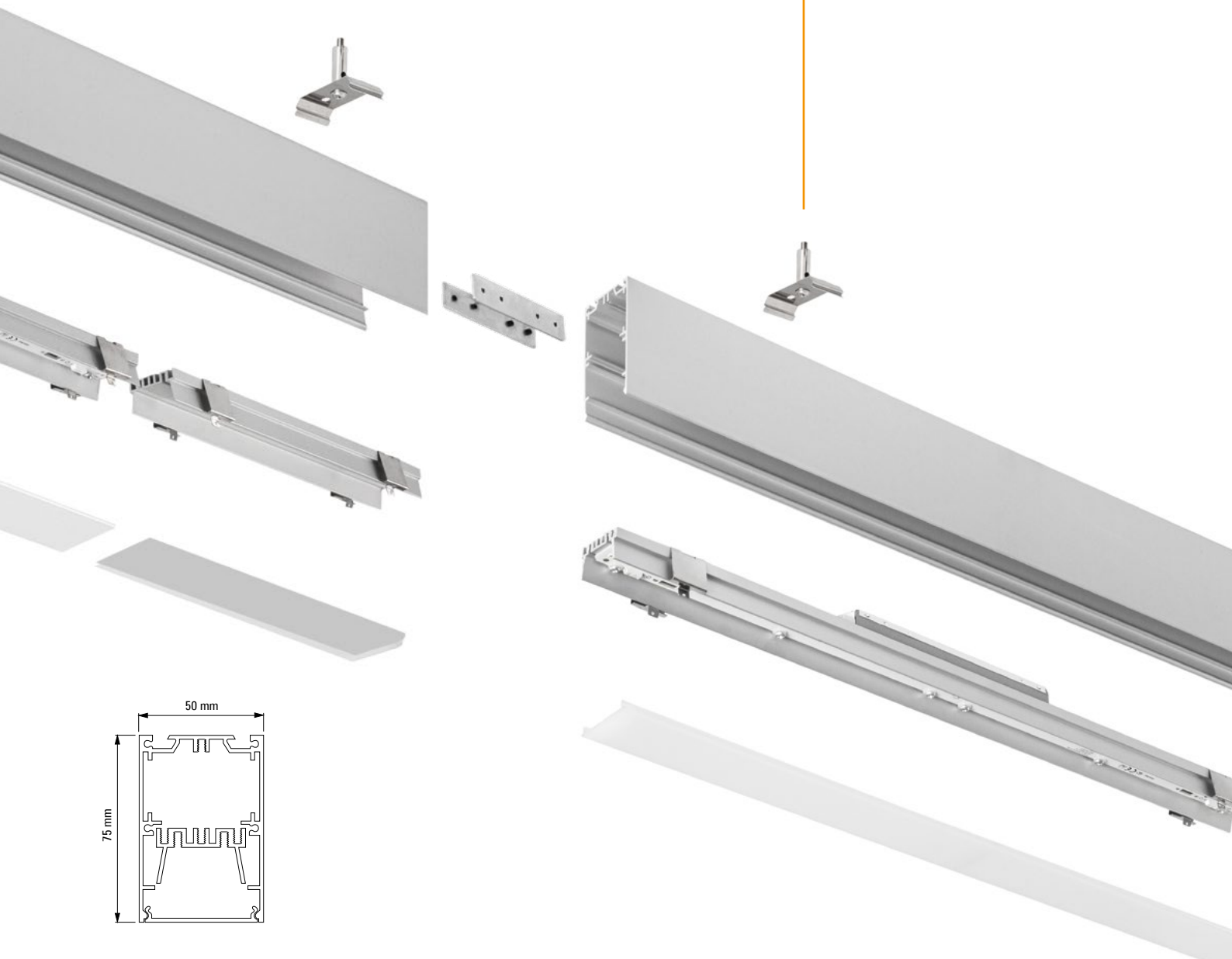

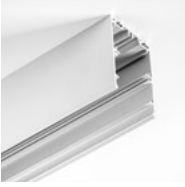

ca. 3,0kg | 1000mm



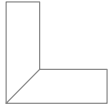
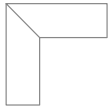
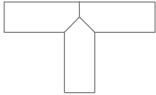

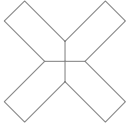
LINEA M [SYSTEM]

Type	Lenght [mm]	CRI+CCT *	Dimming	Colour
	Aluminium empty profile			■
	LTS 307 EP 1000 [cut to required length] ■	1000		AA (ANODIZED ALUMINIUM)
	LTS 307 EP 2000 [cut to required length] ■	2000		WH (WHITE)
	LTS 307 EP 3000 [cut to required length] ■	3000		BL (BLACK)
	LED linear inserts			■ ■
	low power: 14W 1200lm 1000mm			
	LTS 307 1/7 LED LI ■ ■	565	830	
	LTS 307 1/10 LED LI ■ ■	845	835	
	LTS 307 1/14 LED LI ■ ■	1125	840	ON/OFF
	LTS 307 1/17 LED LI ■ ■	1405		DALI
	low power: 14W 1200lm 1000mm			
	LTS 307 1/14 LED L ■ ■	565	830	CASAMBI
	LTS 307 1/20 LED LI ■ ■	845	835	BLL
	LTS 307 1/27 LED LI ■ ■	1125	840	TW (TUNABLE WHITE)
	LTS 307 1/33 LED LI ■ ■	1405		
		Opal Cover		
LTS 307 PM 1000 [cut to required length]		1000		
LTS 307 PM 2000 [cut to required length]		2000		
	Aluminium Blind Cover			■
	LTS 307 BC 1000 [cut to required length] ■	1000		AA (ANODIZED ALUMINIUM)
	LTS 307 BC 2000 [cut to required length] ■	2000		WH (WHITE)
				BL (BLACK)
	L Junction 90DEG horizontal			■
	LTS 307 LJH ■			AA (ANODIZED ALUMINIUM)
				WH (WHITE)
				BL (BLACK)
	L Junction 90DEG vertical for wall-ceiling connection			■
	LTS 307 LJV ■			AA (ANODIZED ALUMINIUM)
				WH (WHITE)
				BL (BLACK)
	T Junction			■
	LTS 307 TJ ■			AA (ANODIZED ALUMINIUM)
				WH (WHITE)
				BL (BLACK)

Type		Lenght [mm]	CRI+CCT *	Dimming	Colour
	X Junction LTS 307 XJ ■				■ AA (ANODIZED ALUMINIUM) WH (WHITE) BL (BLACK)
	Invisible line connectors 180DEG (pair) LTS 307 ILC				GALVANIZED STEEL
	Invisible line connectors for any angle connections (pair) LTS 307 ILCA				GALVANIZED STEEL
	End Caps LTS 307 EC ■ (pair)	50x75x2			■ AA (ANODIZED ALUMINIUM) WH (WHITE) BL (BLACK)
	Power supply LTS 307 PS 3x0,75mm2 2000 ■ LTS 307 PS 5x0,75mm2 2000 ■ other execution and lenghts on request	2000 2000			■ AA (ANODIZED ALUMINIUM) WH (WHITE) BL (BLACK)
	Ceiling brackets LTS 307 CB (pair)				STAINLESS STEEL
	Suspension Wire Kit LTS 307 SWK 2000 other lenghts on request	2000			STAINLESS STEEL